



# SQUAREPARKER

Puzzle-principle based XY-pallets

Fully automated parking system on up to 4 parking levels in several rows one next to and after another. Without the need of ramps or garage lanes.



- MAP Industry Group
- 43 West 33rd Street Suite 200
- New York NY 10001 USA
- Tel (212) 252-2207 · Fax (800) 961-4568
- [info@nussbaumparking.com](mailto:info@nussbaumparking.com) · [www.nussbaumparking.com](http://www.nussbaumparking.com)

## GENERAL INFORMATION

The **NUSSBAUM SQUAREPARKER** is the fully automated solution for parking cars on up to 4 levels in rows one next to and after another. The vehicles will be re-sorted with a puzzle-principle-based system. As you don't need any ramps or garage lanes, our automatic parking system exploits the available room at the best. Your cars will also be safe from vandalism, theft and weather. Our SQUAREPARKER is also eco-friendly thanks to its compact and accurately planned construction.

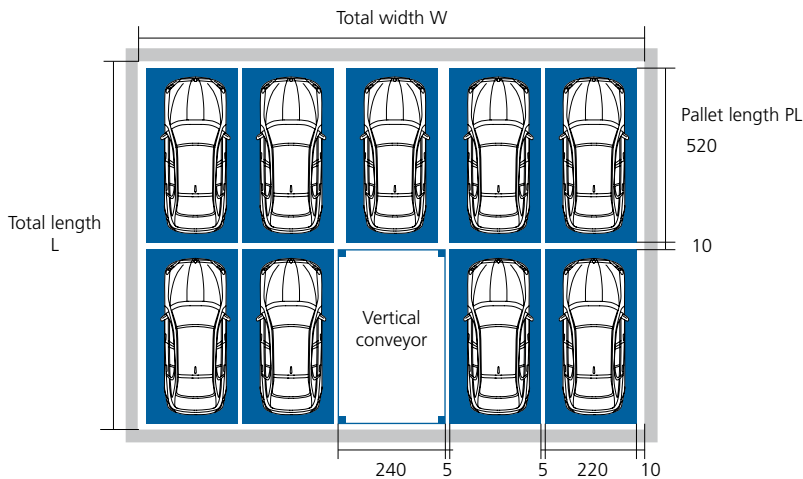

### ADVANTAGES

- No need of ramps or garage lanes
  - Less room required compared a normal parking garage
  - Individual project adaptation (possibility to drive around building pillars)
  - Safety from vandalism and theft
  - High ease-of-use:
- Several operational versions available (radio remote control, RFID, smart phone, etc.)

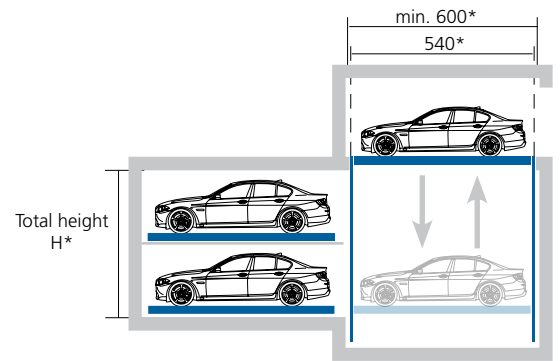
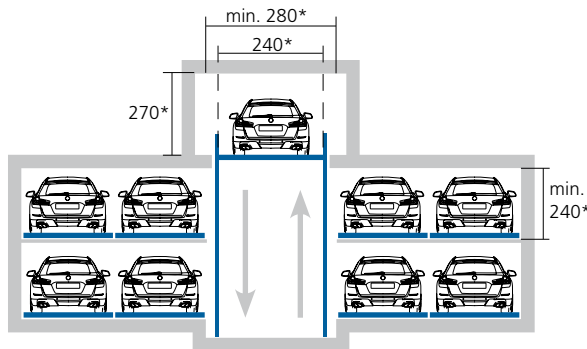

### TECHNICAL DATA

VEHICLE WIDTH	PALLET WIDTH W	VEHICLE LENGTH	PALLET LENGTH PL <sup>1</sup>	VEHICLE HEIGHT	TOTAL HEIGHT H <sup>2</sup>	PARKING ROWS (one after another)	PALLET LENGTH	TOTAL LENGTH L <sup>3</sup>
195	215	470	490	150	190	2	520 cm	1070 cm
200	220	480	500	160	200	3	520 cm	1595 cm
210	230	500	520	180	220	4	520 cm	2120 cm
230	250	520	540	200	240	5	520 cm	2645 cm

<sup>1</sup> We suggest planning the pallets size at least 20cm wider and 20 cm longer (10cm per side) than the vehicle, in order to avoid collision risks.

<sup>2</sup> The total height will be calculated as follows: vehicle height + 40cm inserted ceiling and pallet. The information about the total height apply to one only level. The total height of several levels can be calculated multiplying the amount of levels by the total height per level.

<sup>3</sup> Total length: Pallet length + 10cm distance from the wall (2x) + 5cm distance between the pallets + 5cm tolerance.

# TRANSFER AREA

The transfer area allows you to park the vehicle inside the parking system. The ground of the transfer area is constituted by the lift platform in the upper position. According to the lifting height and space available on site, two types of lifts are available: the 4-columns lift, for high lifting heights and the scissors lift, for lower lifting heights up to 6m. The scissors solution allows for minimal transfer area dimensions. For further information please also see "Turntable in the transfer area" on the next page.

## SCISSORS LIFT

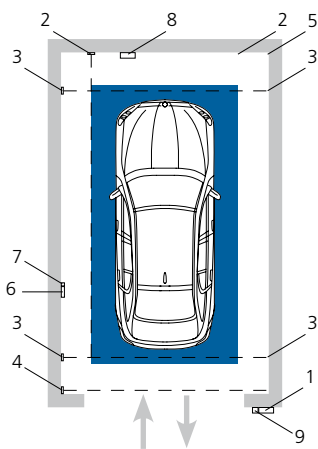

Space-saving solution for lifting heights up to 6m.

## 4-COLUMNS LIFT

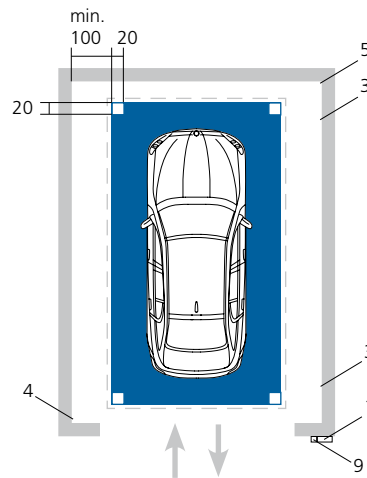

For lifting heights from 6m. It needs at least 15cm additional width at each side of the pallet.

Pos.	Description
1	Control panel (surface or flush mounting, optional controlling units, see page 2).
2	Width control
3	Length control
4	Height control
5	Pallet engaged
6	Emergency-stop
7	Gate-opening button
8	Control indicator - Vehicle positioning
9	Stoptlight (red/green)

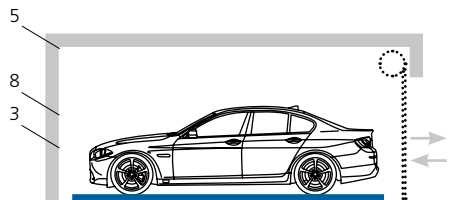
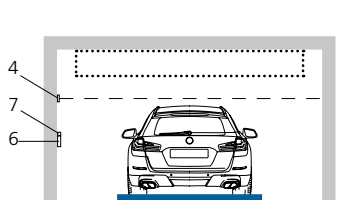

Standard configuration

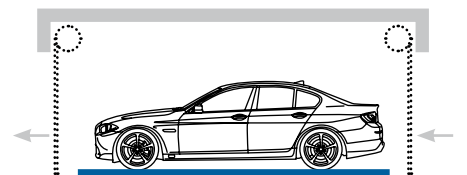

Optional configuration:  
Drive-through transfer area

## GATES

As standard we suggest installing roller shutters according to the safety specifications of the TÜV Südwest e.V. and the current EU Norms. Also solutions employing sectional gates or slide gates are possible, please contact us for further details. The gates need to feature separated control signals for „Open gate“ and „close gate“.

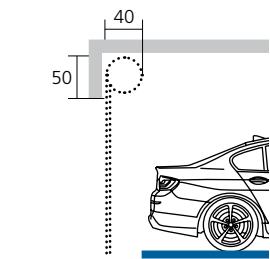
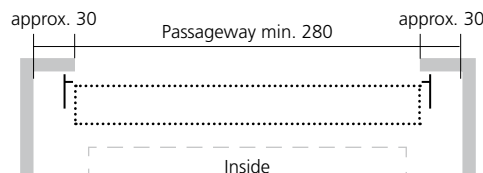
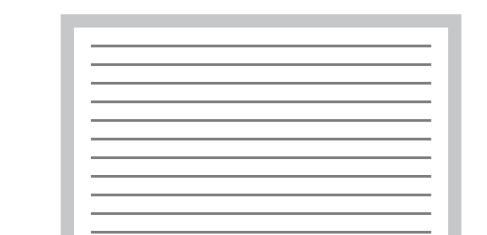

## TURNTABLE

High parking comfort is provided by the turntable, which allows for driving in and out of the parking system without the need of carrying out complex parking manoeuvres.

The turntable can be installed directly in the transfer area or inside the car storage area.

### TURNTABLE IN THE TRANSFER AREA

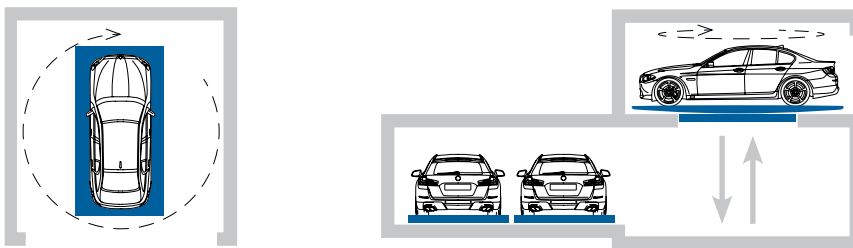

In case the vehicle will be turned in the transfer area, the dimensions of the transfer area need to be adapted accordingly in order to accommodate the turntable.

We suggest positioning the turntable in the transfer area for more comfort while parking in and out of the parking system, thus speeding up access times.

### TURNTABLE ON AN INTERMEDIATE LEVEL

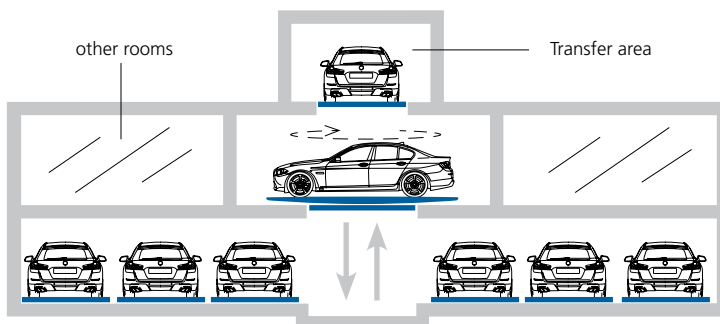

The turntable can be installed on an intermediate level, in case in the transfer area there is not enough room to accommodate it and/or one intermediate level cannot or only partly be used as a parking level.

### TURNTABLE IN THE PARKING LEVEL

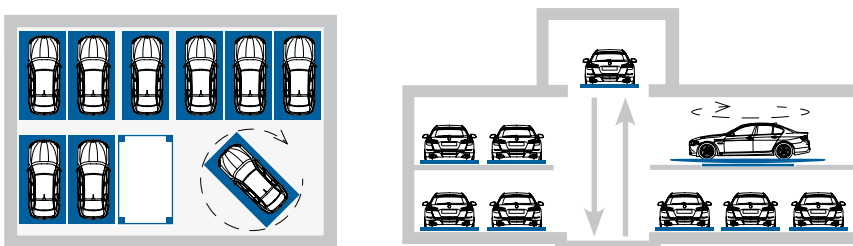

The turntable can also be installed on a parking level. Anyway please mind that this solution means the necessity to give up parking spaces.

# CASE EXAMPLE 1 – System on one level

The below case example shows 9 parking spaces on one parking level on two rows.

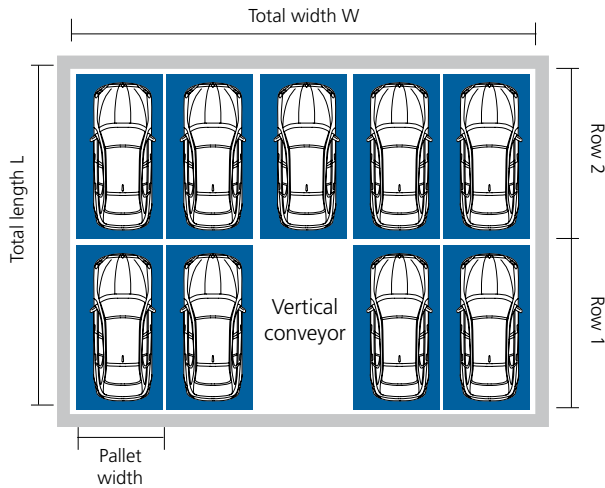

## THE CASE EXAMPLE AT A GLANCE

- 9 Parking spaces
- 1 Parking level
- Vertical conveyor as scissor lift
- Parking spaces are distributed on two rows after another (without empty space)
- Empty space for pallets movement on the lift
- Transfer area as standard on the level above but it can also be placed in other positions
- XY-principle based sliding, also with small circular movements
- Possibility to drive around building pillars
- Supporting structure made of concrete (by customer)

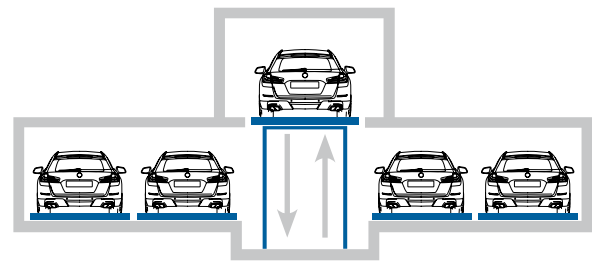
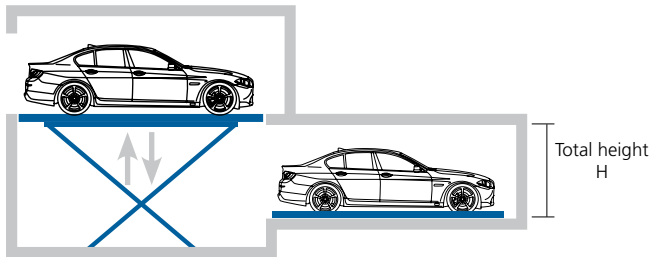

PARKING SPACES* FOR 2 ROWS	"W" BY 230 CM PALLET WIDTH	"W" BY 215 CM PALLET WIDTH
7 (4+3)	1200	1125
9 (5+4)	1435	1345
11 (6+5)	1670	1565
13 (7+6)	1905	1785
15 (8+7)	2140	2005
17 (9+8)	2375	2225
19 (10+9)	2610	2445

\* Additional parking spaces are also possible. In brackets are mentioned the number of pallets per row (row without + row with vertical conveyor). The above mentioned total width "W" is referred to a complete row without taking into consideration empty spaces or vertical conveyors and is calculated as follows: 5cm distance of the pallets to the wall + 10cm distance between the pallets + pallet width.

VEHICLE HEIGHT*	TOTAL HEIGHT H
150	190
160	200
170	210
180	220
190	230
200	240

\* Total height "H" is the minimal height necessary and includes 30cm height concrete intermediate ceilings + 10cm pallet height.

PALLET LENGTH	TOTAL LENGTH L
500	1030
510	1050
520	1070
530	1090
540	1110
550	1130

Total length "L" is calculated as follows: 10cm distance of the pallets to the wall + 5cm distance between the pallets + pallets length in each row + 5cm tolerance. This value does not take any building pillars into consideration.



## FALLBEISPIEL 2 – System auf drei Ebenen

The below case example features 48 parking spaces on three parking levels on three rows one after another.

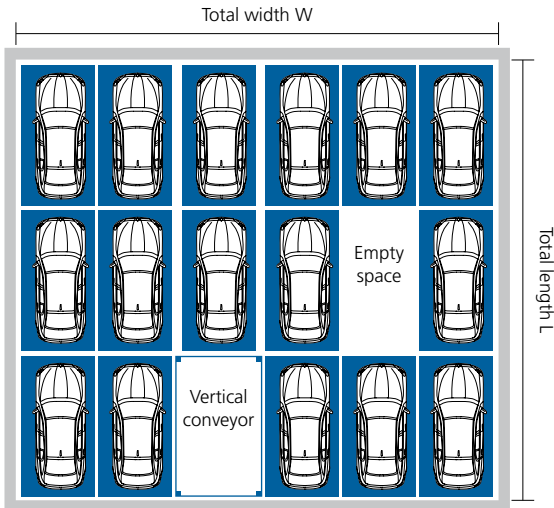

### THE CASE EXAMPLE AT A GLANCE

- 48 parking spaces
- 3 parking levels
- Vertical conveyor as 4-columns lift
- Parking spaces are distributed on three rows one after another
- At least one empty space necessary, plus one further empty space on the lift
- Transfer area as standard on the level above but can also be placed in other positions
- XY-principle based sliding, also with small circular movements
- Possibility to drive around building pillars
- Supporting structure made of concrete by customer

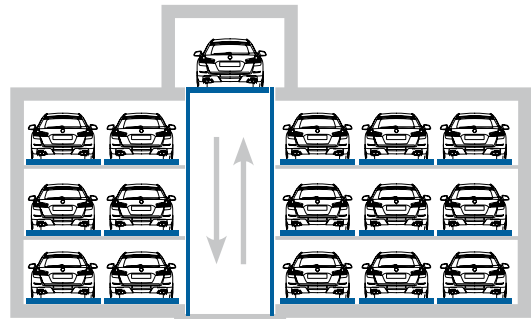
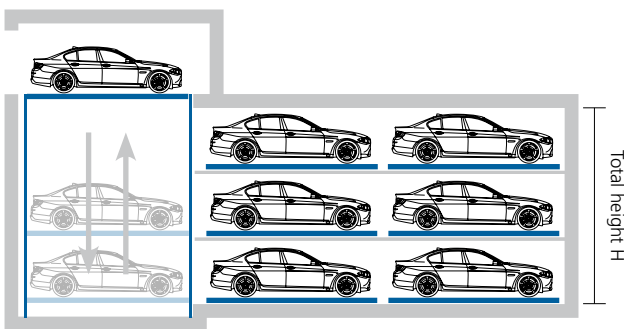

VEHICLE HEIGHT	TOTAL HEIGHT H
150	540
160	570
170	600
180	630
190	660
200	690

Total height "H" includes 30cm height concrete intermediate ceilings + 10cm pallet height.

PALLET LENGTH	TOTAL LENGTH L
500	1545
510	1575
520	1605
530	1635
540	1665
550	1695

Total length "L" is calculated as follows: 10cm distance of the pallets to the wall + 5cm distance between the pallets + 15cm distance between pallet and lift + pallets length in each row + 5cm tolerance. This value does not take any building pillars into consideration.

PALLET WIDTH	TOTAL WIDTH W
215	1360
220	1390
225	1420
230	1450
240	1510
250	1570

Total width "W" is calculated as follows: 10cm distance of the pallets to the wall + 5cm distance between the pallets + 15cm distance between pallets and 4-columns lift + pallets width in each row + 5cm tolerance. This value does not take any building pillars into consideration.

# LAYOUT OPTIONS

## POSITION OF THE VERTICAL CONVEYOR / TRANSFER AREA

The position of the vertical conveyor and transfer area can be chosen on an individual basis. The standard layout features a central arrangement of the lift but can it can also be positioned at the corners or in front of the parking system.

A: Standard layout – At the centre

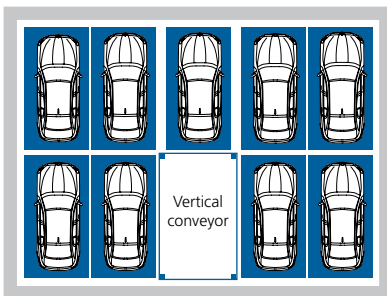

B: Optional layout – at the corner

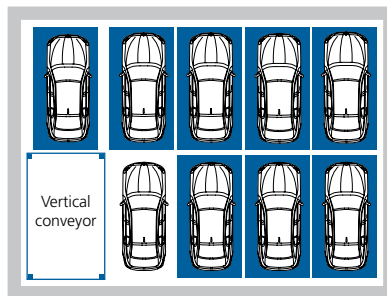

C: 2nd optional layout – at the front

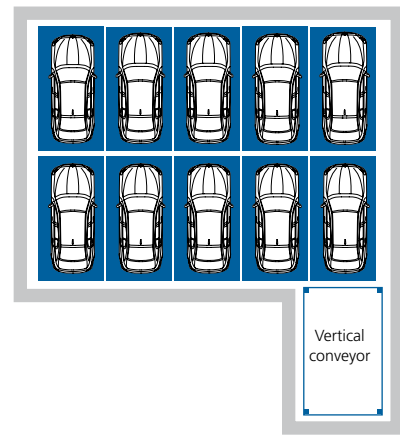

D: 3rd optional layout – on the parking level\*

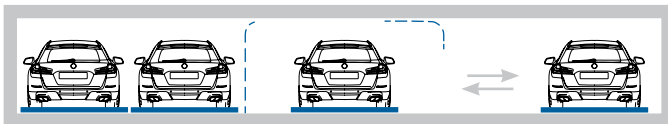

It is also possible to place the transfer area inside one parking level. Roller shutters delimit the user area from the parking levels and are only opened in case a vehicle is being parked or retrieved.

\*Such placing is only suggested if the versions A to C are not feasible.

## ARRANGEMENT ON SEVERAL ROWS

Depending on the space available on site, it is also possible to foresee more than two rows one after another. The number of necessary empty spaces for pallets movement will be foreseen accordingly.

2 rows

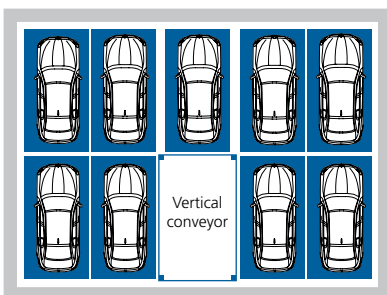

3 rows

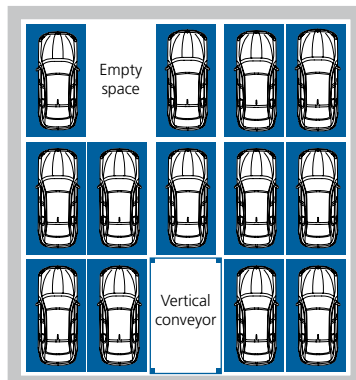

4 rows

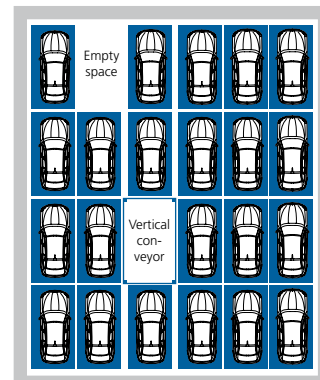

# TECHNICAL INFORMATION



## STATIC AND CONSTRUCTION

Fastening on concrete ceiling(s) by customer, concrete quality at least C25/30; Supporting structure also as steel construction available, please contact us.

## LIGHTING (BY CUSTOMER)

In the transfer area at least 500 Lux (see EN 1837:1999). On the parking levels at least 50 Lux (see EN 81-1:1998).

## WATER DRAINING

Our parking pallets are conceived in order to collect possible dropping water. An additional draining system connected with a pump well avoids dripping water onto the vehicles and the structure. The pump well shall be provided by customer

## DECLARATION OF CONFORMITY

Our products are developed according to the machines guidelines 2006/42/EG generally and particularly to the DIN EN 14010.

## FIRE PROTECTION(BY CUSTOMER)

Fire protection system shall be foreseen according to the specifications of the competent authorities and shall be carried out by customer after consultation.

## EARTHING AND EQUIPOTENTIAL BONDING

Each 10/20 m shall earthing be foreseen by customer. The equipotential bonding rails shall be connected to the earthing with as short wires as possible. Steel constructions shall be connected to the earthing with as short wires as possible.

## VENTILATION

Ventilation will be needed in order to reduce the air humidity and shall be foreseen by customer according to DIN 60204-1.

## TAILOR-MADE SOLUTIONS

We offer tailor-made solution for your individual field of application. Please feel free to contact us in order to discuss the most suitable solution to your needs.

## DIMENSIONS

All dimensions are minimum finished dimensions. Tolerances according to VOB part C (DIN18330, 18331) shall be additionally observed.

All dimensions are in cm.

## NOISE INSULATION

Noise insulation shall comply with DIN 4109 (at least R'w 57 dB(A)).

## SUPPORTING STRUCTURE

The case examples in this brochure feature intermediate ceilings made of concrete. As an option we also offer the possibility to deliver a steel supporting structure for the pallet system. Please feel free to contact us for a project specific solution.

## NOTE

Dimensional and structural data are subject to modification.